

Model No. C2C42



Features:

- Five high performance Coyote Infinity Burners™
- 1275 sq. in. cooking area
- Up to 100,000 BTU
- Complete 304 stainless steel construction
- Interior grill lighting
- Integrated wind guard

Dimensions:

- Cutout: (H) 10 1/4" X (W) 39 1/2" X (D) 20 1/2"
- Overall: (H) 23" X (W) 42" X (D) 25 1/2"

Accessories:

- Laser-Cut Signature Grates (CSIGRATE15)
- Charcoal trays (CCHTRAY15)
- 14" stainless steel griddle (C1GRDL)
- Stainless steel cart available (C142CT)
- Custom fit, weather resistant cover
- Insulated jacket
- Gas conversion kit

C2C42 PRODUCT SPECS

DIMENSIONAL RENDERINGS

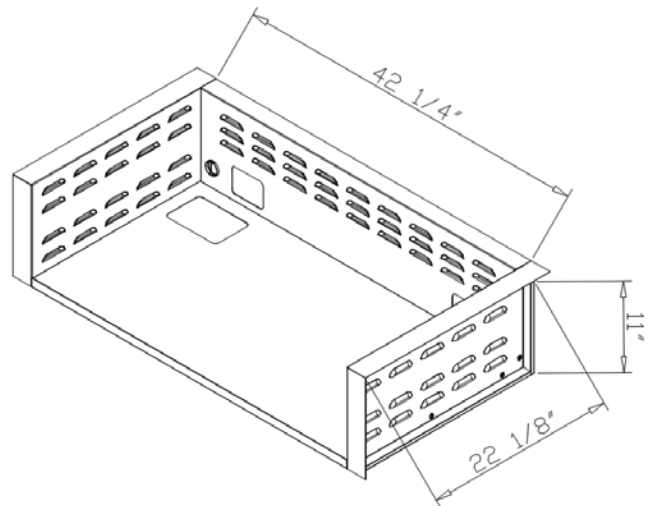
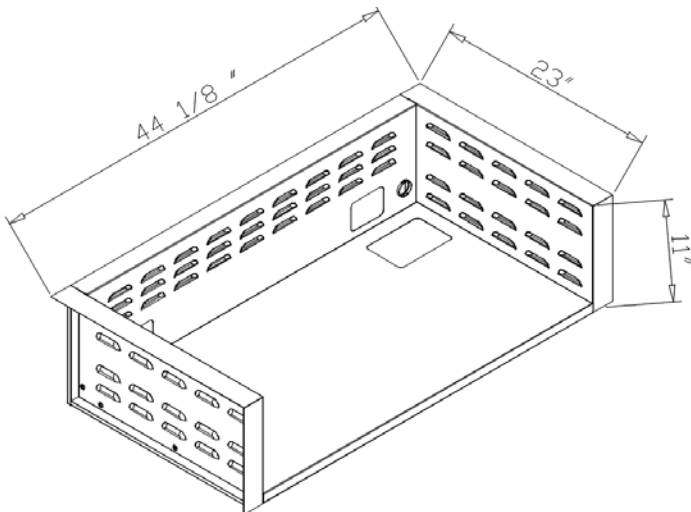
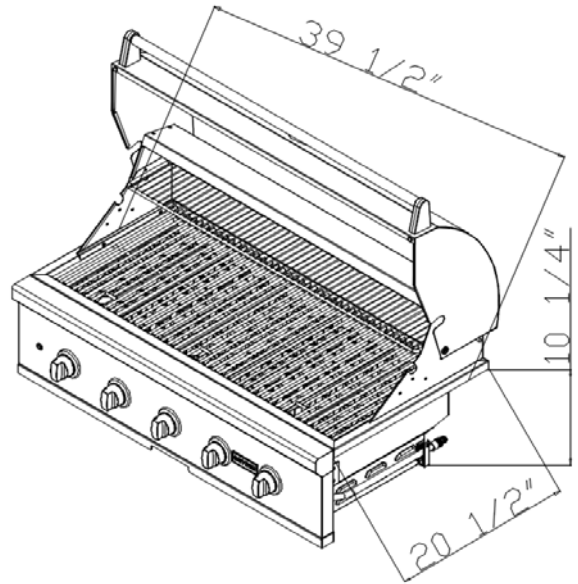
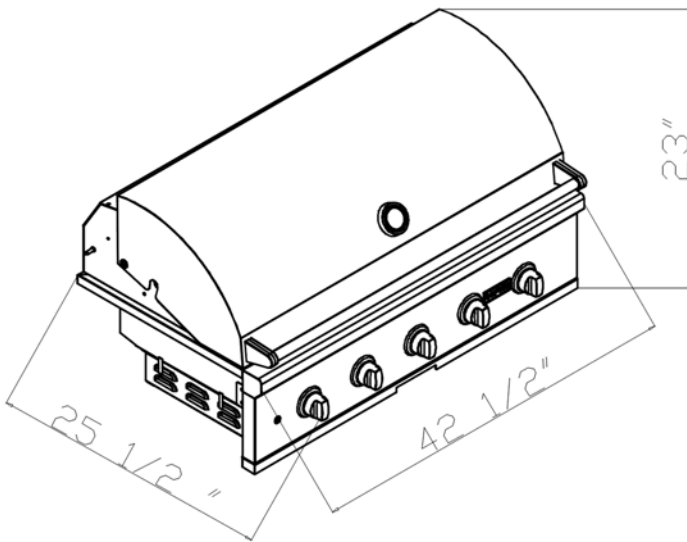

Overall Product Dimensions

Model No.	Height	Width	Depth
C2C42	23"	42 1/2"	25 1/2"
CJAKTCS42	11"	44 1/8"	23"

Cutout Dimensions for Island

Model No.	Height	Width	Depth
C2C42	10 1/4"	39 1/2"	20 1/2"
CJAKTCS42	11"	42 1/4"	22 1/8"

✓ When using a Coyote insulated jacket, you will want to build your island to the jacket's Cutout and Overall Dimensions listed above. Once the jacket is installed, the grill will rest on/inside the insulated jacket

Model No.	Gas Supply	BTU's	Regulator	WC Pressure	Max PSI	Electrical Requirements
C2C42LP	Propane	100,000	20 lb Tank Regulator	11"	.5 PSI	Qty 1 - 120 VAC 60 Hz Grounded Plug
C2C42NG	Natural Gas	100,000	1/2" Female Pipe	4"	.5 PSI	Qty 1 - 120 VAC 60 Hz Grounded Plug

Important Note to Installer: This file is not intended to replace your Owners' Manual which contains specific safety requirements and consumer guidelines. Please refer to your Owners' Manual prior to installing or operating your built-in grill.