

# CB465UI



<b>Product family</b>	Refrigerator
<b>Installation</b>	Built-in
<b>Category</b>	Bottom mount
<b>No-frost system</b>	Total
<b>Cooling type</b>	Total no-frost - Dual-flow cooling system
<b>Defrost</b>	Automatic
<b>Hinge</b>	Door-to-door
<b>Kitchen panel</b>	Not supplied
<b>Hinge position</b>	Right
<b>Reversible door</b>	Yes
<b>EAN code</b>	8017709313739



## Aesthetic

<b>Aesthetics</b>	Universal	<b>Drawers profile color</b>	Silver
<b>Handle</b>	Not included	<b>Glass shelf profile color</b>	White
<b>Side material</b>	Steel	<b>Display</b>	TFT
<b>Logo</b>	Silkscreened	<b>Display position</b>	Internal
<b>Door shelf profile color</b>	Silver		

## Refrigerator compartment features



<b>No. of adjustable shelves</b>	2	<b>Type of crisper cover</b>	Glass
<b>Number of fruit and vegetables drawers</b>	1	<b>LifePlus zone - 32°F</b>	Yes
<b>Type of adjustable shelves</b>	Glass	<b>Refrigerator lighting</b>	Yes
<b>Crisper drawer type</b>	Standard	<b>Refrigerator lighting</b>	LED
<b>Crisper cover</b>	Yes		

## Refrigerator Inner Door

<b>Number of adjustable door shelves</b>	2	<b>No. of bottle shelves</b>	1
--	---	------------------------------	---

## Other Refrigerator features



Natural plus blue light Yes

MultiFlow Yes

## Freezer features

Number of drawers 1

## Other Freezer features



Ice maker Yes

Ice-tray shelf Yes

Fast-freezing compartment Yes

## Other technical features



Display functions

Holiday, Fast-freezing, Fast-cooling, ECO, Child lock, Temperature alarm, Sabbath

Fast-freezing button

Yes

Water network connection

Yes

Power-on light

Yes

Temperature alarm

Yes

Door open alarm

Yes

Temperature setting type

Electro-mechanical

No. of compressors

1

Refrigerant gas type

R600a

Compressor type

Inverter

Foam agent

Cyclopentane

## Performance / Energy Label NEW

Noise level 44 dB(A) re 1pW

## Electrical Connection

Plug (A) USA & Mexico

Voltage (V) 120 V

Current 2 A



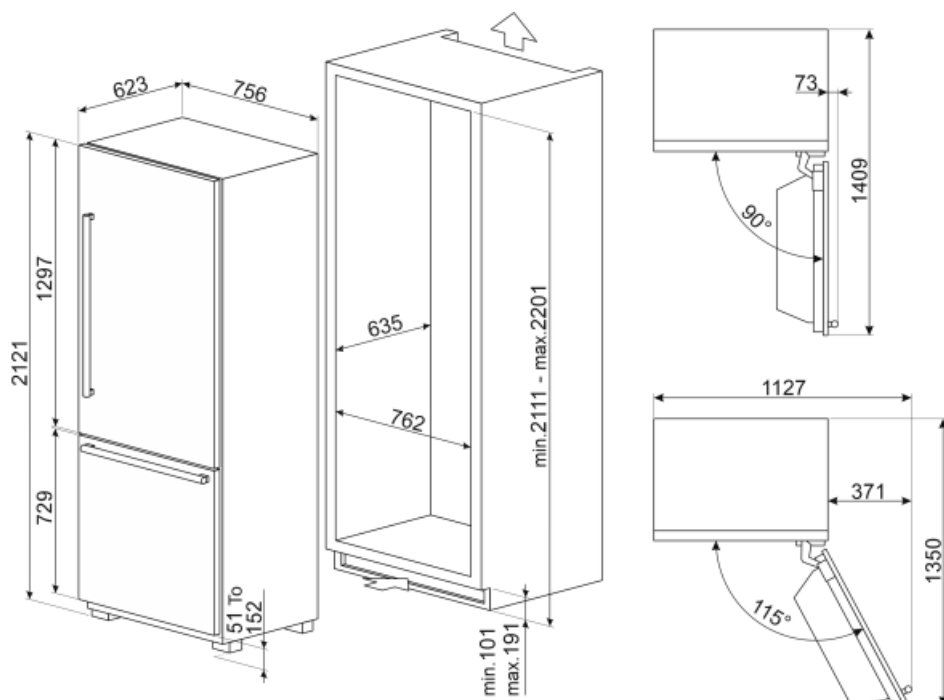







Frequency (Hz) 60 Hz



---

## Symbols glossary (TT)

---

	The automatic defrost system works by automatically defrosting at regular intervals eliminating the need to defrost altogether.		Child lock: some models are fitted with a device to lock the programme/cycle so it cannot be accidentally changed.
	Economical mode: Analyzes fridge functioning during the activation and optimizes the operating cycle in order to reduce power consumption.		Fast freezing: The fast freezing function brings the temperature of the compartment down when activated a few hours prior to usage.
	Power saving mode: The power saving mode allows you to disable the refrigerator and keep the freezer working.		LED interior lighting: is a more energy efficient and long lasting way of illuminating the interior of the appliance.
	Life Plus 0°C: The temperature in the Lifeplus compartments is kept at 0°C, which preserves fresh meat and fish longer.		Inverter technology: The evolution of Smeg's driers towards more intelligent and environmentally sustainable models has led to the choice of using Inverter technology with heat pumps, which reduces significantly energy consumption.
	Air plus: keeps food fresher for longer.		Natural Plus Blu Light: This unique Natural Plus Blu Light system works with nature to increase the storage time of fruit and vegetables.