

- Volume of 5.5 cubic feet, holds (219) 12 oz cans or (107) 12 oz bottles
- Matte black prepainted cabinet exterior
- Black interior
- Electronic control with LED display
- Temperature range: 34 °F to 65 °F
- Fan-assisted cooling system allows for even temperatures, quicker cooldown times, and added efficiency
- Cool white LED lighting
- Modular racking system includes 3 glass shelves
- Unit ships right hinged with field-reversible door
- Model includes a 3/4" diameter vertical stainless steel handle
- Door close assist hinge helps ensure door closure
- Precise zero clearance design allows for unmatched integration into any built-in setting
- 4 Independent adaptable leveling legs
- Fixed stainless steel toe-kick
- Automatic defrost
- Perfect for indoor and outdoor applications
- Energy Star rated



Model Details

Model	Finish	Description	Shipping Weight
SR243SS	Stainless Steel	24" Indoor/Outdoor Premium Refrigerator	160 lbs

Dimensions/Weight	Detail
Product Depth	25 1/4"
Product Height	33 3/4" - 34 3/4"
Product Width	23 7/8"
Product Weight	128 lbs
Product Volume	5.5 cu ft
Shipping Dimensions	26 1/2" x 27 1/2" x 35 1/4"
Shipping Weight	160 lbs



The Legacy Companies warrants to the original purchaser of its SAPPHIRE products that they will be free from defects in materials and workmanship for the following time periods from the date of purchase shown on the sales receipt:

Two (2) Years Parts & On-Site Labor | Five (5) Years Compressor Warranty (Parts Only)

See complete warranty for details.

SapphireAppliances.com | 1.866.754.6672
The Legacy Companies

3355 Enterprise Avenue, Suite 160, Fort Lauderdale, FL 33331

Model	Details
Control Type	Electronic Control with LED Display
Indoor or Outdoor	Indoor/Outdoor
Built-in Installation	Inset, Frameless / Overlay and Framed Cabinet Styles
Refrigerant Type	R600a

Electrical	Details
Electrical Requirements	115 V / 60 Hz
Volt Range	104 V ~ 127 V
Electrical Service	15 amp
Running Amps	1.1 amps

Approvals - Certifications	Details
Energy Star	Yes
ETL Residential / Commercial	Yes, Residential
ETL Sanitation	No
Sabbath Mode	Yes

Capacities	Details
12 oz Can Capacity	219 Cans (Max)
12 oz Bottle Capacity	107 Bottles (Max)

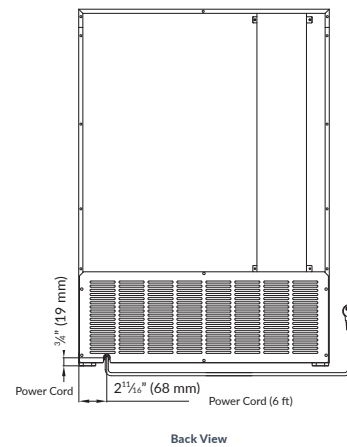
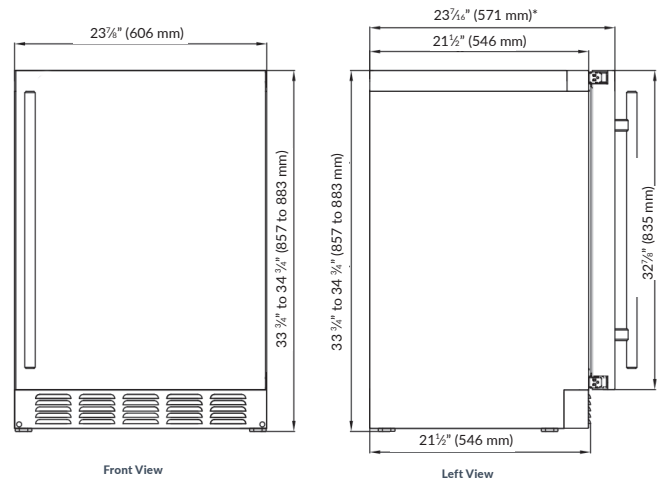
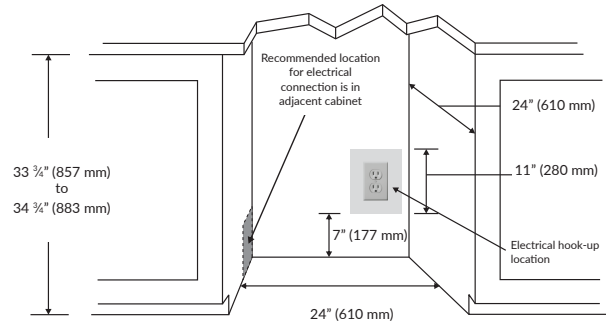

The Legacy Companies warrants to the original purchaser of its SAPPHIRE products that they will be free from defects in materials and workmanship for the following time periods from the date of purchase shown on the sales receipt:

Two (2) Years Parts & On-Site Labor | Five (5) Years Compressor Warranty (Parts Only)

See complete warranty for details.

SapphireAppliances.com | 1.866.754.6672
The Legacy Companies

3355 Enterprise Avenue, Suite 160, Fort Lauderdale, FL 33331

SAPSS17
080823